

qualiton APR 204 ● User's manual

Introduction

Thank you for purchasing a **qualiton APR204** preamplifier!

It is designed to deliver a high standard of musical performance. The innovation in engineering and manufacturing this product guarantees amusement for a long time, thanks to the output transformer made by us.

We wish you many pleasant hours of musical experience with your **qualiton APR204!**

CONTENTS

PREFACE.....	2
CONTENTS OF PACKAGE.....	3
TECHNICAL SPECIFICATION.....	4
FRONT PANEL CONTROLS.....	5
REAR PANEL TERMINALS.....	6
REMOTE CONTROL.....	7
REPLACEMENT OF BATTERY	8
INSTALLATION.....	9
SAFETY RECOMMENDATIONS - PLACEMENT	10
SAFETY RECOMMENDATIONS - OPERATION	11
FIRST INSTALLATION	13
CONNECTING.....	14
TROUBLESHOOTING	15
MARKINGS.....	17
REPLACEMENT OF FUSE	18
WASTE MANAGEMENT	19
WARRANTY.....	20
DECLARATION OF CONFORMITY.....	21

PREFACE

Before installing the **Qualiton APR 204**, please study this user manual carefully!

Operating your preamplifier in a manner it is designed for ensures you an utmost musical experience and a reliable operation.

If you have any questions on our products or services, please do not hesitate to contact us on our website www.audiohungary.com

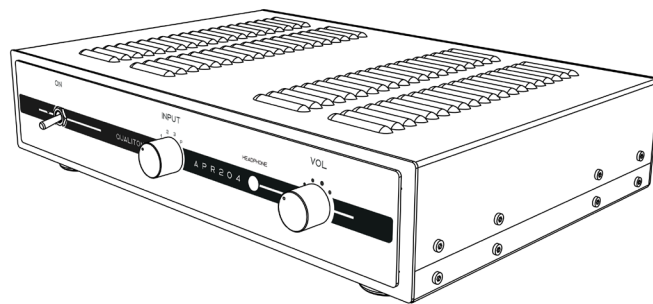

CONTENTS OF PACKAGE

- 1 pc – Qualiton APR 204 preamplifier
- 1 pc – User manual
- 1 pc – Standard mains cable

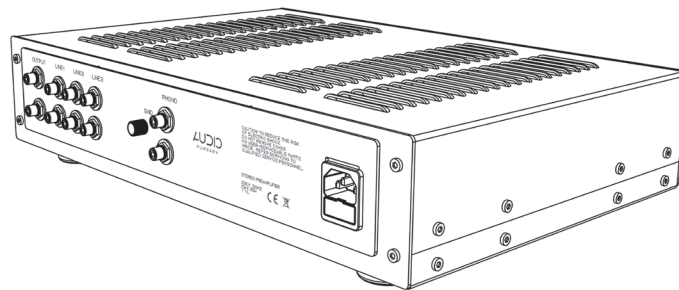

TECHNICAL SPECIFICATION

LINE STAGE

INPUT SENSITIVITY
500 mV

MAXIMUM INPUT SIGNAL
7 V

GAIN
12 dB

TOTAL HARMONIC DISTORTION
< 0,05 %

FREQUENCY RESPONSE
4 Hz-300 kHz (-1 dB)

INPUT IMPEDANCE
100 kOhm

SIGNAL-TO-NOISE RATIO
> 100 dB

VACUUM TUBE SET
4 x ECC83; 2 x E88CC

PHONO STAGE

INPUT SENSITIVITY
5 mV

MAXIMUM INPUT SIGNAL
200 mV

GAIN
52 dB (1 kHz)

TOTAL HARMONIC DISTORTION
< 0,5 %

FREQUENCY RESPONSE
20 Hz-20 kHz (-0.3 dB)

INPUT IMPEDANCE
47 kOhm

SIGNAL-TO-NOISE RATIO
> 70 dB

WEIGHT
8.4 kg

FRONT PANEL CONTROLS

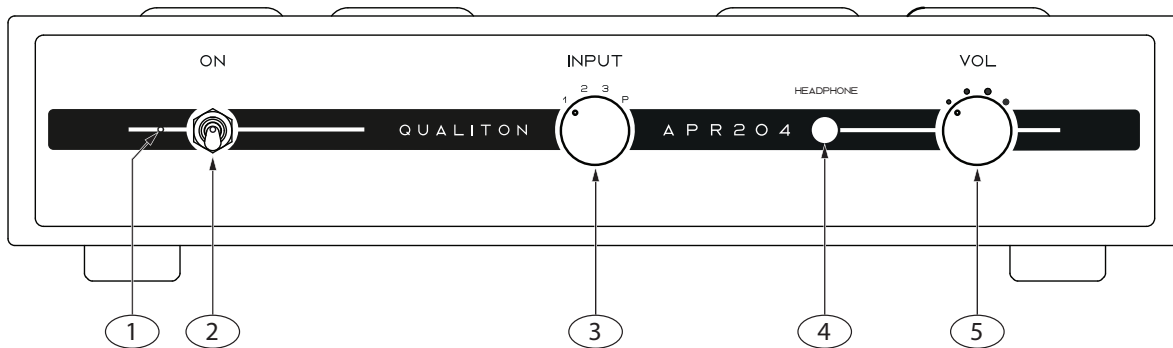

① Status indicator led

② Main switch

③ Input selector rotary switch

1: Line 1

2: Line 2

3: Line 3

P: Phono (MM)

④ Headphone output
(6,3mm)

⑤ Volume control

qualiton APR 204

REAR PANEL TERMINALS

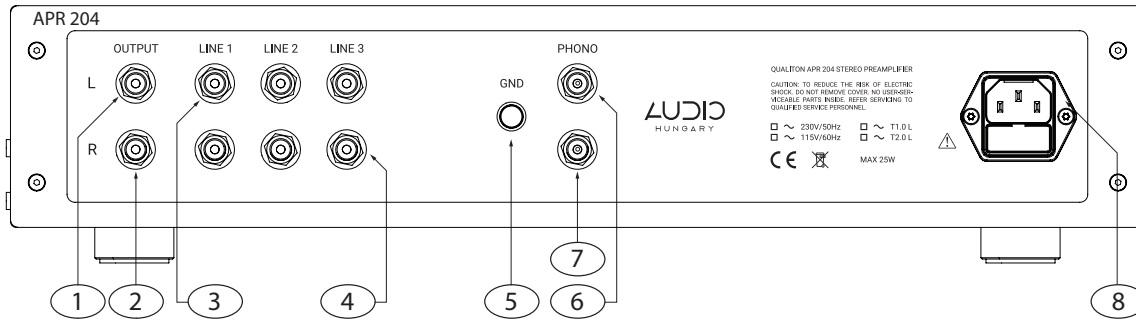

- ① Line output - Left side (L)
- ② Line output - Right side (R)
- ③ Inputs (3 RCAs placed horizontally) Left side (L)
- ④ Inputs (3 RCAs placed horizontally) Right side (R)

- ⑤ Grounding screw
- ⑥ Phono line input - Left side (L)
- ⑦ Phono line input - Right side (R)
- ⑧ AC socket with fuse box

REMOTE CONTROL

- ① LED indicating communication
- ② Volume up
- ③ Volume down
- ④ Mute

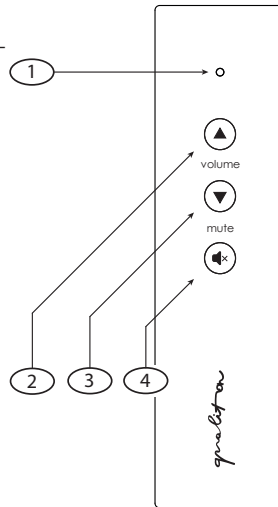

Should your remote control not operate, remove its back with the torx wrench, included in the package, and replace the one A23 battery!

REPLACEMENT OF BATTERY

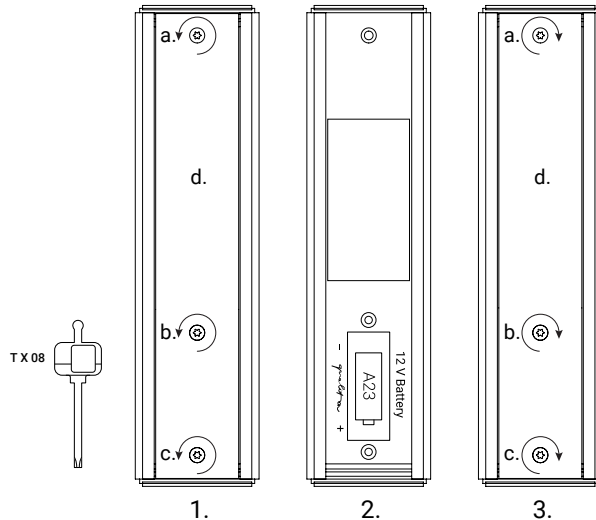

1. Unscrew the screws on the back (a.b.c.) with the torx wrench, included in the package, then remove the cover! (d.)

2. Insert one A23 battery, as shown in the diagram!

3. Put back the cover and fasten it tightening the screws!

INSTALLATION

- Due to the vacuum tube construction of the preamplifier, it may heat up during use. Thus, choose a location for installation where the appliance can be well ventilated!
- Make sure that cables connecting the preamplifier to the speakers as well as cables connected to the ports of the preamplifier can be effortlessly connected.!
- Appliance can only operate with 50 Hz frequency and 230V AC voltage! The standard AC socket and the fuse box are placed at the rear panel.
- Never operate the preamplifier through an ungrounded outlet!

SAFETY RECOMMENDATIONS - PLACEMENT

- Avoid relocating the appliance from cold to warm surroundings! Sudden temperature changes can lead to moisture condensation. Please wait until moisture is evaporated before putting your preamplifier into operation!
- The aforesaid applies to the very first installation of the preamplifier as well. Prior to the first installation, leave the preamplifier at its place of operation at least for 2 hours. Once this time is over, the preamplifier can be powered up!
- The appliance is designed for indoor use. Do not operate it in wet, humid surroundings!
- Do not store any electrical device or object in a perimeter of 200 millimetres around your preamplifier!
- The ventilation holes of the preamplifier must not be covered (by tablecloth, curtain, newspaper, book, etc.)! Impairing ventilation can lead to overheating and irregular operation conditions!
- Do not use the appliance next to heating sources and radiators! Keep it away from hot or dusty environment and flame!

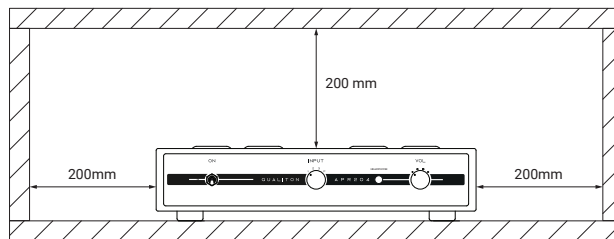

SAFETY RECOMMENDATIONS - OPERATION

- Improper installation may cause breakdown!
- Before powering up your preamplifier, make sure cover, ports, plugs and cables are checked for intactness!
- You must not start up damaged or faulty appliance. In case of any malfunction, unplug your preamplifier immediately!
- Components must not be changed or repaired by the user. In case of a malfunction, the cover must not be opened or removed!
- In case of an emergency, unplug your preamplifier immediately!
- In case of a faulty operation, contact our service!
- Improper repair may lead to a loss of warranty!
- The appliance may only be used by qualified adults or children above 14 years of age if supervised by a qualified adult!
- Keep the appliance out of the reach of children!
- Make sure your domestic animal does not lie or sit on the top of the appliance!
- Irrespective of protection circuits built in in your amplifier, always make sure it is connected and operated in a proper manner!

SAFETY RECOMMENDATIONS - OPERATION

- At the mains cable and output ports, there is a risk of electric shock! They must be handled with care!
- If you do not use your preamplifier for a long time, unplug the appliance carefully!
- Do not block the openings of your preamplifier since this may lead to fire or electric shock!
- The protection rating of this appliance is IP20. This means the appliance is protected from solid objects larger than 12 millimetres. However, it is not protected from moisture!
- Operation voltage is 230V AC, operation frequency is 50/60 Hz!
- Never operate the preamplifier through an ungrounded outlet!
- The AC socket features a built-in fuse box. Ensure replacement fuses with rating T 1 L (type time-delay)!

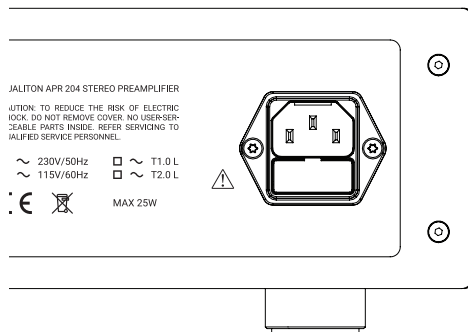

SAFETY RECOMMENDATIONS - OPERATION FIRST INSTALLATION

- Be careful with appliance cables! Do not lead them across sharp surfaces, do not clamp them together and do not leave them in a hanging position!
 - You must not operate the appliance with damaged cables!
 - In case of fire, you must not use water to extinguish the fire, even if the preamplifier is powered down!
 - Never touch the appliance or its mains cable with wet hands!
 - Clean the appliance with a dry cloth while it is unplugged!
- Connect your preamplifier to the other elements of your sound system according to the connection diagram!
 - Plug in your appliance!
 - Switch the main switch on the left to the position "ON".

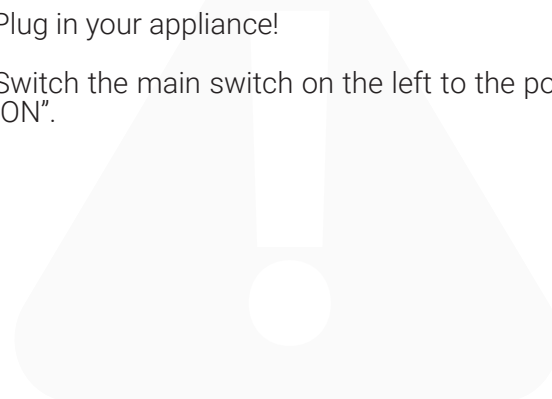

qualiton APR 204

CONNECTING

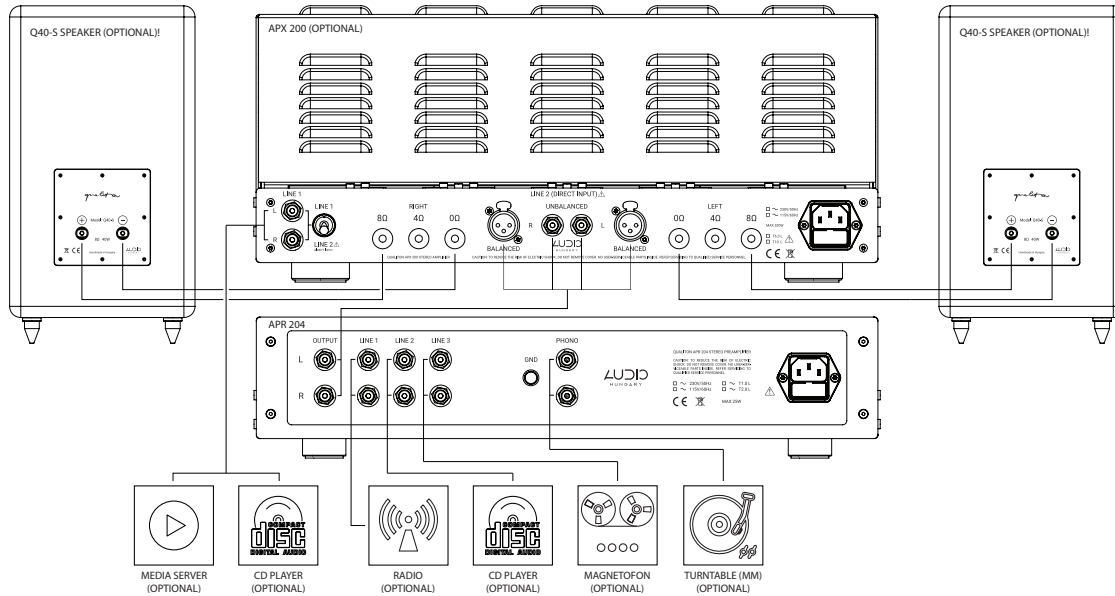

TROUBLESHOOTING

Malfunction 1: Preamplifier does not power up.

- 1.a Make sure the preamplifier is plugged in!
- 1.b Be sure the main switch at the front panel is in 'ON' position!
- 1.c Should the fault persist after going through points 1.a and 1.b, carefully check the mains cable for intactness!
- 1.d Should the fault persist after going through points 1.a, 1.b and 1.c, check whether the front panel gauge illuminates red! If it does not, check the power supply of your flat!
- 1.e Should the fault persist after going through points 1.a, 1.b, 1.c and 1.d, check the fuse of the preamplifier for intactness, according to the instructions stated in 'Safety Recommendations—Operation'!
- 1.f If the preceding points are all checked and the preamplifier still does not power up (incl. the bias indicator), please contact our company!

TROUBLESHOOTING

Malfunction 2: The illumination of the front panel bias indicator does not turn warm white.

2.a Wait 90 seconds until the start-up delay circuits are activated! Should the gauge illumination not turn into warm white after 90 seconds, please contact our company!

Malfunction 3: No sound from the speakers.

3.a Check the operation of the preamplifier according to section 1!

3.b Be sure that the audio source is connected to the input ports of the preamplifier!

3.c Be sure that the audio source is turned on!

3.d Be sure that the volume control knob is turned up!

3.e Be sure that the speaker cables are correctly connected to the correct ports!

3.f Check whether the speaker cables are correctly connected to the speaker ports!

3.g If the preceding points are all checked and the fault persists, please contact our company!



Malfunction 4: No sound from one side, no stereo sound.

4.a Check the operation of the preamplifier according to sections 1 and 2!

TROUBLESHOOTING

- 4.b Change your audio source! Make sure you are listening to a stereo record!
- 4.c If the preceding points are all checked and the fault persists, please contact our company!

MARKINGS

-  - The product meets the directives and standards of the European Union.
- 230 V - Nominal supply voltage.
- 50 Hz - Nominal supply frequency.
-  - Product requiring waste separation.
-  - Warning! This component can only be replaced by components specified in this user manual!

REPLACEMENT OF FUSE

1. Open the fuse holder with a screwdriver!
2. Change the used main fuse (marked b.) for the spare fuse (marked a.)!

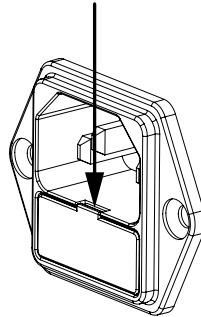

1.

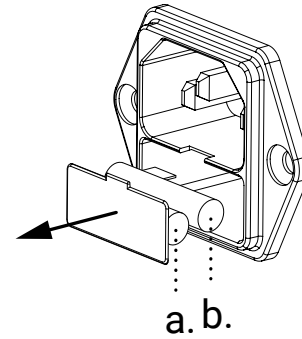

2.

WASTE MANAGEMENT

- The appliance and its packaging are made of recyclable materials.
- The appliance contains repairable or recyclable components and materials. Waste separation makes their recycling possible.
- A faulty appliance or an appliance meant to be discarded has to be sent or brought to an adequate waste collection place or to our company site!
- For further information on waste disposal please contact our company or local authorities.

WARRANTY

The serial number of your appliance (engraved on a metal plate) is placed on its bottom. Please refer to this number while contacting our company.

Set of tubes used:

DECLARATION OF CONFORMITY

We, Audio-Hungary Ltd., declare, taking this declaration under our total responsibility, that tube preamplifier model Qualiton APR204 is in conformity with EN 55013, EN 61000-3-2, EN 61000-3-3, and EN 55020 in accordance with the Directive 2006/95/EC of 12 December 2006.

Document: 2016/03.

Manufacturer:

Audio-Hungary Ltd.
Nádor Street 28.
4400 Nyíregyháza Hungary

We declare that the designated product(s): Qualiton APR204 is/are in conformity with the European Directives:

EN 60065:2015
EN 55014-1:2006+A1:2009+A2:2011
EN 55014-2:2006+A1:2009+A2:2011

This declaration certifies compliance with the indicated directives but implies no warranty of properties. The safety instructions of the accompanying documentation shall be observed. This declaration of conformity is issued under the sole responsibility of the manufacturer.

Issuer:

Audio-Hungary Ltd.
Nádor Street 28.
4400 Nyíregyháza Hungary

Legally binding signature:

AUDIO-HUNGARY Kft.
4400 Nyíregyháza
Nádor utca 28.

Andras Imre Fabian

Place, date: Hungary, 26.11.2016

AUDIO
HUNGARY

AUDIO-HUNGARY Ltd. HUNGARY
28. NÁDOR STR. 4400 NYÍREGYHÁZA

WWW.AUDIOHUNGARY.COM