

Qualiton PHONO © User's Manual

CONTENTS

PREFACE	2
CONTENTS OF PACKAGE	3
TECHNICAL SPECIFICATION	4
FRONT PANEL	5
REAR PANEL TERMINALS	6
MM / MC CARD REPLACEMENT	7
MC CARD SWITCH TABLE	8
INSTALLATION	10
SAFETY RECOMMENDATIONS - PLACEMENT	11
SAFETY RECOMMENDATIONS - OPERATION	12
FIRST INSTALLATION	14
CONNECTING	15
STATUS INDICATION	16
VACUUM TUBES	16
TROUBLESHOOTING	17
MARKINGS	19
REPLACEMENT OF FUSE	20
WASTE MANAGEMENT	21
WARRANTY	22
DECLARATION OF CONFORMITY	23

PREFACE

Before installing the **qualiton PHONO**, please study this user manual carefully!

Operating your phono stage in a manner it is designed for ensures you an utmost musical experience and a reliable operation.

If you have any questions on our products or services, please do not hesitate to contact us on our website www.audiohungary.com

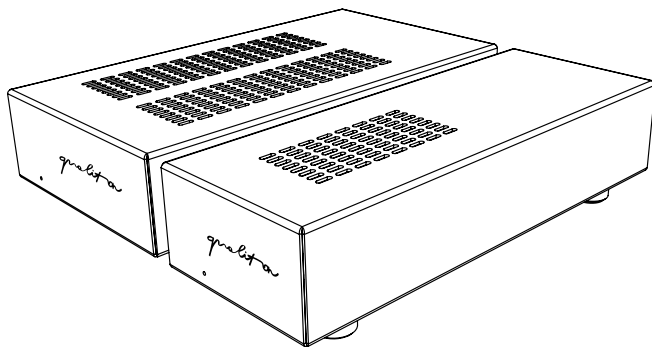

CONTENTS OF PACKAGE

- 1pc qualiton PHONO stage
- 1pc qualiton power supply
- 1pc user manual
- 1pc special DC cable
- 1pc standard mains cable

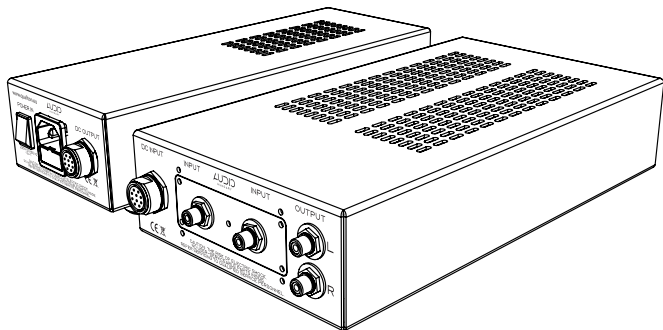

TECHNICAL SPECIFICATION

NOMINAL OUTPUT LEVEL

500 mV

INPUT SENSITIVITY - WITH MM CARD

5 mV, to nominal output level

INPUT SENSITIVITY - WITH MC CARD

0.4 mV, to nominal output level

MAX. INPUT SIGNAL - WITH MM CARD

100 mV

MAX. INPUT SIGNAL - WITH MC CARD

2 mV

GAIN - WITH MM CARD

+40 dB, (f = 1 kHz)

GAIN - WITH MC CARD

+62 dB, (f = 1 kHz)

TOTAL HARMONIC DISTORTION - WITH MM CARD

< 0.07 %, (f = 1 kHz, input level: 5 mV)

TOTAL HARMONIC DISTORTION - WITH MC CARD

< 0.2 %, (f = 1 kHz, input level: 0.4 mV)

SIGNAL-TO-NOISE RATIO - WITH MM CARD

> 70 dB

SIGNAL-TO-NOISE RATIO - WITH MC CARD

> 65 dB

FREQUENCY RESPONSE

20 Hz - 20 kHz, (-0.3 DB)

TUBES REQUIRED

4 x ECC83; 2 x E88CC

WEIGHT

5,4 kg

FRONT PANEL

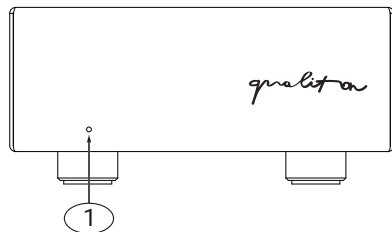

① Status indicator LED

② Power supply status indicator LED

REAR PANEL TERMINALS

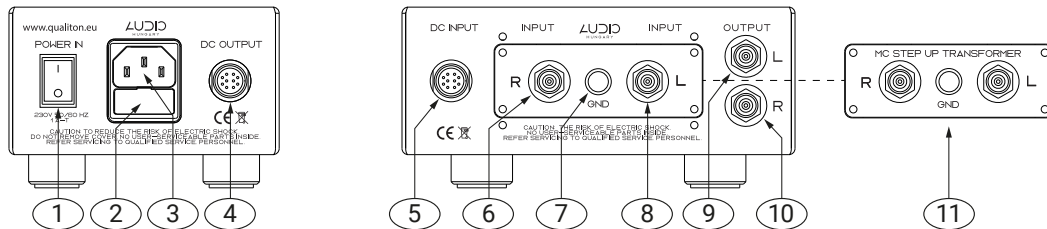

- | | | | |
|--------------------------------------|---|------------------------------|---|
| 1 Main switch | 2 Built-in fuse box in the AC socket | 3 AC socket | 4 DC socket (output) |
| 5 DC socket (input) | 6 Phono line input - Right side (R) | 7 Grounding screw | 8 Phono line input - Left side (L) |
| 9 Line output - Left side (L) | 10 Line output - Right side (R) | 11 MC card (optional) | |



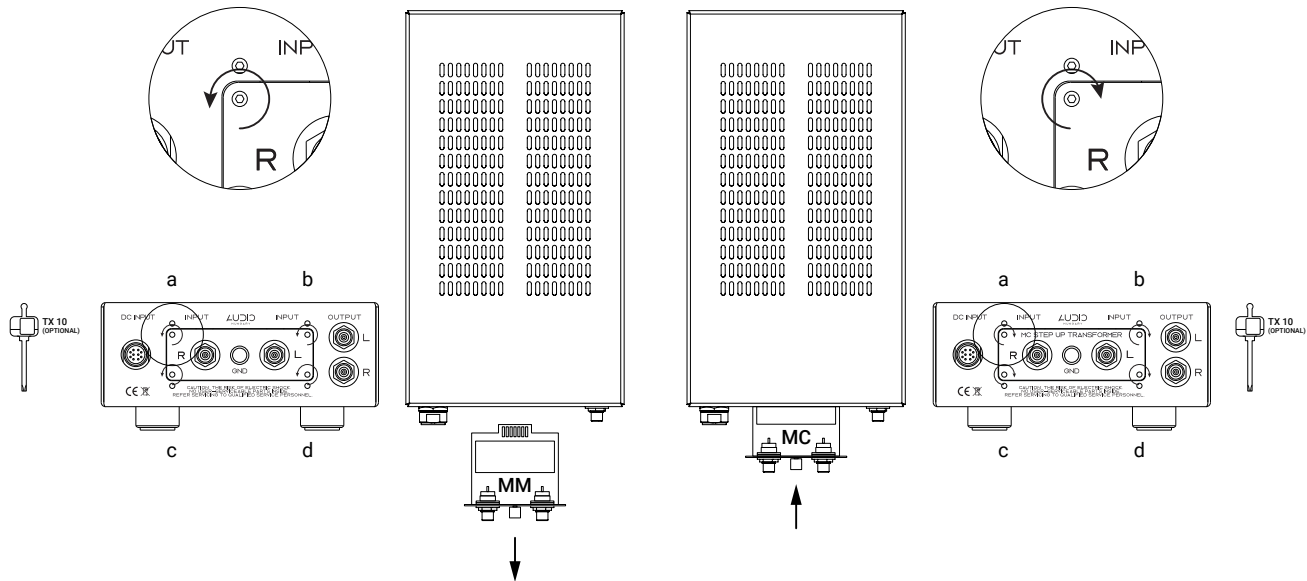









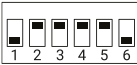

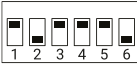
MM / MC CARD REPLACEMENT









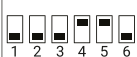







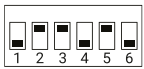

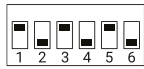
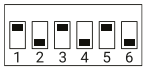
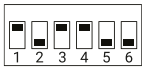
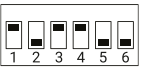







MM / MC CARD REPLACEMENT

- Screw off the a; b; c; d screws!
- Pull out the MM card!
- Put in the MC card!
- Screw in the a; b; c; d screws!





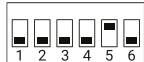

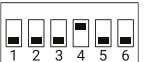



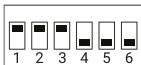

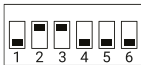
MM CARD SWITCH TABLE (FACTORY DEFAULT)

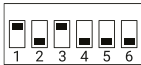
		5900 Ω
		6100 Ω
		6400 Ω
		6600 Ω
		6600 Ω
		7000 Ω
		7500 Ω
		7800 Ω

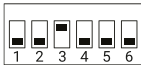
MM CARD SWITCH TABLE (FACTORY DEFAULT)

		7900 Ω			11500 Ω
		8200 Ω			11800 Ω
		8800 Ω			12500 Ω
		9200 Ω			14000 Ω
		9500 Ω			15000 Ω
		10000 Ω			15700 Ω
		10000 Ω			17000 Ω
		11000 Ω			20000 Ω

MM CARD SWITCH TABLE (FACTORY DEFAULT)

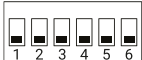
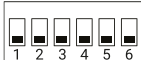
		22000 Ω
		23000 Ω
		26000 Ω
		40000 Ω
		45000 Ω
		58000 Ω
		115000 Ω
		270000 Ω

INSTALLATION

- Due to the vacuum tube construction of the phono stage, the it may heat up during use. Thus, choose a location for installation where the appliance can be well ventilated!
- Make sure that cables connecting the amplifier to the speakers as well as cables connected to the ports of the amplifier can be effortlessly connected!
- Appliance can only operate with 50 Hz frequency and 230V AC voltage! The standard AC socket and the fuse box are placed at the rear panel.

SAFETY RECOMMENDATIONS - PLACEMENT

- Avoid relocating the appliance from cold to warm surroundings! Sudden temperature changes can lead to moisture condensation. Please wait until moisture is evaporated before putting your phono stage into operation!
- The aforesaid applies to the very first installation of the phono as well. Prior to the first installation, leave the phono stage at its place of operation at least for 2 hours. Once this time is over, the phono can be powered up!
- The appliance is designed for indoor use. Do not operate it in wet, humid surroundings!
- Do not store any electrical device or object in a perimeter of 200 millimetres around your qualiton phono!

- The ventilation holes of the phono stage must not be covered (by tablecloth, curtain, newspaper, book, etc.)! Impairing ventilation can lead to overheating and irregular operation conditions!
- Do not use the appliance next to heating sources and radiators! Keep it away from hot or dusty environment and flame!

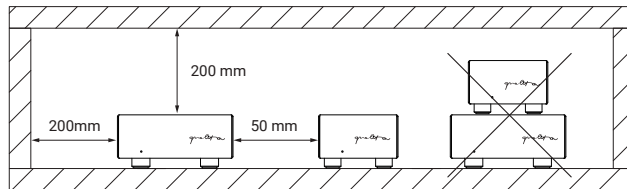

SAFETY RECOMMENDATIONS - OPERATION

- Improper installation may cause breakdown!
- Before powering up your phono stage, make sure cover, ports, plugs and cables are checked for intactness!
- You must not start up damaged or faulty appliance. In case of any malfunction, unplug your phono stage immediately!
- Components must not be changed or repaired by the user. In case of a malfunction, the cover must not be opened or removed!
- In case of an emergency, unplug your phono stage immediately!
- In case of a faulty operation, contact our service!
- Improper repair may lead to a loss of warranty!
- The appliance may only be used by qualified adults or children above 14 years of age if supervised by a qualified adult!
- Keep the appliance out of the reach of children!
- Make sure your domestic animal does not lie or sit on the top of the appliance!
- Irrespective of protection circuits built in in your phono stage, always make sure it is connected and operated in a proper manner!

SAFETY RECOMMENDATIONS - OPERATION

- At the mains cable and output ports, there is a risk of electric shock! They must be handled with care!
- If you do not use your phono stage for a long time, unplug the appliance carefully!
- Do not block the openings of your phono stage since this may lead to fire or electric shock!
- The protection rating of this appliance is IP20. This means the appliance is protected from solid objects larger than 12 millimetres. However, it is not protected from moisture!
- Operation voltage is 230V AC, operation frequency is 50 Hz!
- Never operate the phono stage through an ungrounded outlet!
- The AC socket features a built-in fuse box. Ensure replacement fuses with rating 1A-T (type time-delay)!

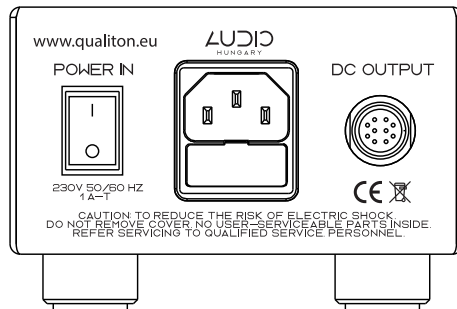

SAFETY RECOMMENDATIONS - OPERATION FIRST INSTALLATION

- Be careful with appliance cables! Do not lead them across sharp surfaces, do not clamp them together and do not leave them in a hanging position!
 - You must not operate the appliance with damaged cables!
 - In case of fire, you must not use water to extinguish the fire, even if the amplifier is powered down!
 - Never touch the appliance or its mains cable with wet hands!
 - Clean the appliance with a dry cloth while it is unplugged!
- Connect your phono stage to the other elements of your sound system according to the connection diagram!
 - Plug in your appliance!
 - Switch the main switch on the left to the position "I" and wait for for the LED under the volume control to turn from red to white!

CONNECTING

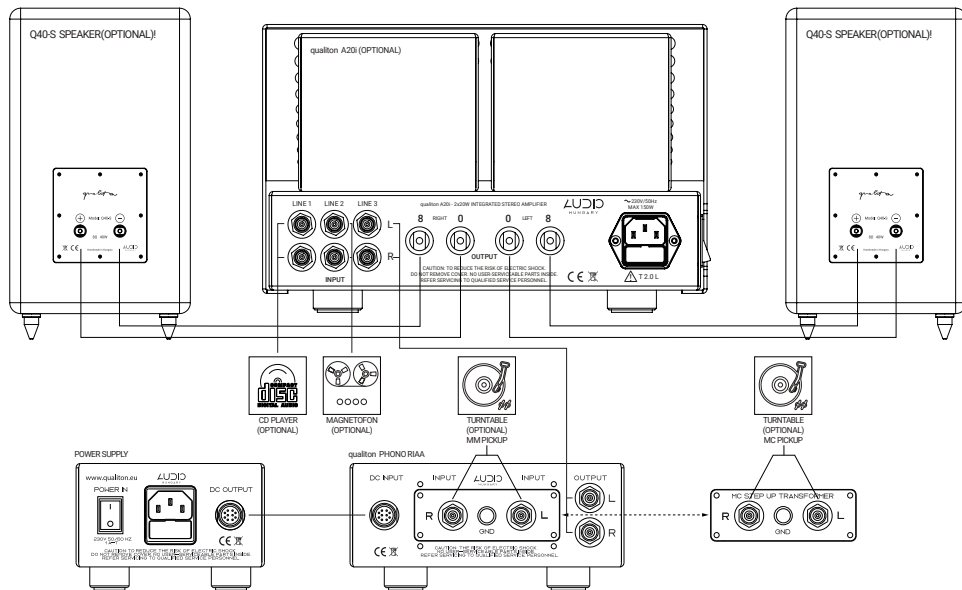

STATUS INDICATION

- The status indication LED is placed at the front panel. The LED can indicate the followings:
 - No illumination
Appliance powered down.
 - White coloured light
Current flows through the vacuum tubes, according to the anode current value set by the manufacturer.

VACUUM TUBES

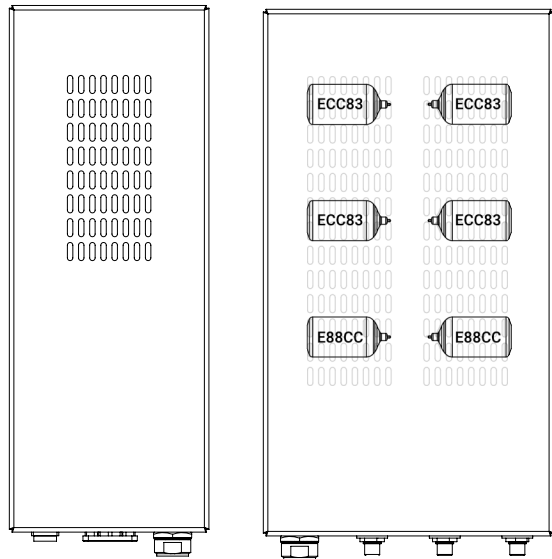

TROUBLESHOOTING

Malfunction 1: Phono stage does not power up.

- 1.a Make sure the phono stage is plugged in!
- 1.b Be sure the main switch is in 'I' position!
- 1.c Should the fault persist after going through points 1.a and 1.b, carefully check the mains cable for intactness!
- 1.d Should the fault persist after going through points 1.a, 1.b and 1.c, check whether the front panel gauge illuminates white! If it does not, check the power supply of your flat!

1.e Should the fault persist after going through points 1.a, 1.b, 1.c and 1.d, check the fuse of the amplifier for intactness, according to the instructions stated in 'Safety Recommendations—Operation'!

1.f If the preceding points are all checked and the amplifier still does not power up (incl. the status indicator), please contact our company!

Malfunction 2: The illumination of the status indicator LED does not turn white.

2.a Should the indicator illumination not turn into white after 60-90 seconds, please contact our company!

TROUBLESHOOTING

Malfunction 3: No sound from the speakers.

- 3.a Check the operation of the phono stage according to section 1 and 2!
- 3.b Be sure that the audio source is connected to the input ports of the phono stage!
- 3.c Be sure that the audio source is turned on!
- 3.d Be sure that the volume control is turned up!
- 3.e Be sure that the speaker cables are correctly connected to the correct ports!

3.f Check whether the speaker cables are correctly connected to the speaker ports!

3.g If the preceding points are all checked and the fault persists, please contact our company!

Malfunction 4: No sound from one side, no stereo sound.

4.a Check the operation of the phono stage according to sections 1 and 2!

4.b Change your audio source. Make sure you are listening to a stereo record!

TROUBLESHOOTING

4.c If the preceding points are all checked and the fault persists, please contact our company!

Malfunction 5: Noisy and/or distorted sound.

5.a Check the operation of the phono stage according to sections 1, 2 and 3! Should the fault persist, please contact our company!

Malfunction 6: The top of the phono stage is hot.

6.a Due to the inner circuitry of the phono stage, this is a normal phenomenon. For further information check section 'INSTALLATION'.

MARKINGS

 - The product meets the directives and standards of the European Union.

230 V - Nominal supply voltage.

50 Hz - Nominal supply frequency.

 - Product requiring waste separation.

REPLACEMENT OF FUSE

1. Open the fuse holder with a screwdriver!
2. Change the used main fuse (marked b.) for the spare fuse (marked a.)!

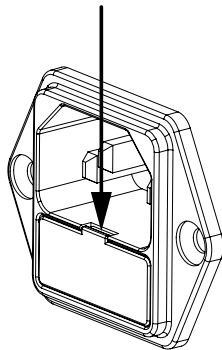

1.

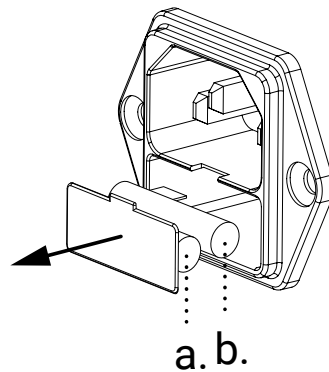

2.

WASTE MANAGEMENT

- The appliance and its packaging are made of recyclable materials.
- The appliance contains repairable or recyclable components and materials. Waste separation makes their recycling possible.
- A faulty appliance or an appliance meant to be discarded has to be sent or brought to an adequate waste collection place or to our company site!
- For further information on waste disposal please contact our company or local authorities.

WARRANTY

The serial number of your appliance (engraved on a metal plate) is placed on its bottom. Please refer to this number while contacting our company.

Set of tubes used:

DECLARATION OF CONFORMITY

We, Audio-Hungary Ltd., declare, taking this declaration under our total responsibility, that MC transformer model Qualiton MC is in conformity with EN 55013, EN 61000-3-2, EN 61000-3-3, and EN 55020 in accordance with the Directive 2006/95/EC of 12 December 2006.

Document: 2016/05.

Manufacturer:

Audio-Hungary Ltd.
Nádor Street 28.
4400 Nyíregyháza Hungary

We declare that the designated product(s): Qualiton MC is/are in conformity with the European Directives:

EN 60065:2015
EN 55014-1:2006+A1:2009+A2:2011
EN 55014-2:2006+A1:2009+A2:2011

This declaration certifies compliance with the indicated directives but implies no warranty of properties. The safety instructions of the accompanying documentation shall be observed. This declaration of conformity is issued under the sole responsibility of the manufacturer.

Issuer:

Audio-Hungary Ltd.
Nádor Street 28.
4400 Nyíregyháza Hungary

Place, date:

Hungary , 26.11.2016

Legally binding signature:

AUDIO-HUNGARY Kft.
4400 Nyíregyháza
Nádor utca 28.

Andras Imre Fabian



AUDIO-HUNGARY Ltd. HUNGARY
132. DERKOVITS St. 4400 NYÍREGYHÁZA

WWW.AUDIOHUNGARY.COM